

NC24T Universal Controller with LCD Installation, Configuration and Parameter Setup Manual

Dimensions in mm

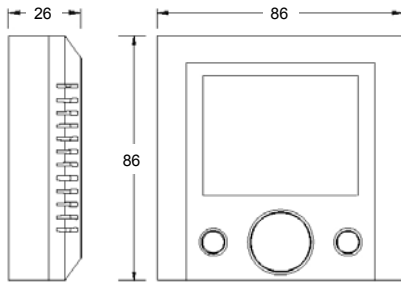

Mounting Details

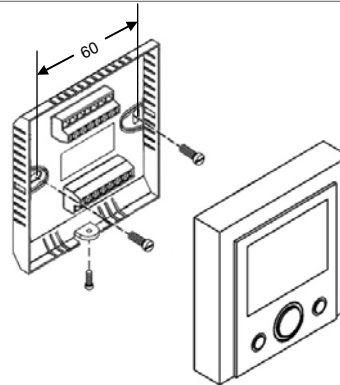

Mounting

The universal controller can be surface mounted or secured to a standard European 75 x 75 x 35 mm electrical box or on a control panel. Two mounting screws are included.

Wiring Terminals and Jumper Settings

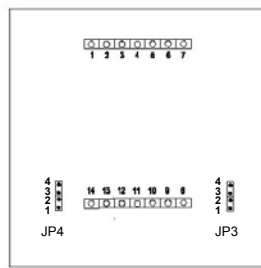
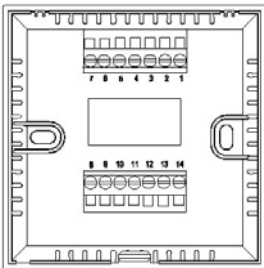

Jumper Settings for Inputs X1 and X2	
Jumper	Socket Position
JP3	Insert at position 3 & 4 for 0...10 V active input X1 (Factory setting), Insert at position 1 & 2 for TE10 sensor input
JP4	Always at position 3 & 4 for 0...10 input X2

Inputs and Outputs

Input / Output	Terminal No.	Description
Universal input X1	11	Universal input X1 can be used as the primary input with a TE10 Series NTC temperature sensor or an active 0...10 VDC active signal. Refer to jumper table and setup menu for details of settings
Analogue input X2	12	The analog input X2 is used as the secondary input with a 0...10 VDC active signal that allows remote set-point override, higher input priority or higher output priority. Refer to setup menu for details of configurations.
Digital input DI1	8	The digital input DI1 is used to activate the ECO-mode (Energy-saving mode)
Digital input DI2	9	The digital input DI2 is used to activate day/night changeover.
Digital output Q1	3	24 VAC 2-position output for either reverse or direct acting
Digital output Q2	6	24 VAC 2-position output for either reverse or direct acting
3-point output Y1	3 and 4	3-point modulating output for either reverse or direct acting
3-point output Y2	6 and 7	3-point modulating output for reverse acting

Applications of Inputs X1, X2, DI1 and DI2

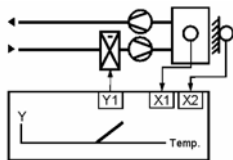

Higher input priority

X2 will be used as input parameter and LCD will display its equivalent value when X2 is greater than X1.

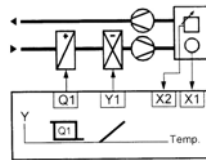

Remote set-point

A remote 0...10V signal input to X2 which is used as local set-point override.

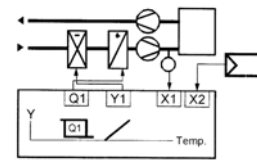

Higher output priority

The value of X2 will be used as Y1 output when its value is greater than calculated output of cooling sequence

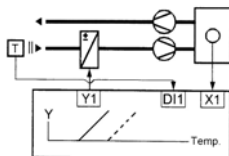

Eco-Mode

The local set-point will be overridden by Eco-mode set-point when DI1 is in closure.

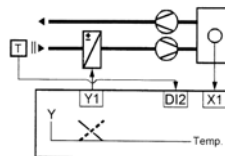

Day/night changeover

The Y1 output will be inverted when DI2 is in closure.

Remarks:

Please refer to the setup menu shown on page 3 for configuration details of X1, X2 and Eco-mode function. Illustrations of application specific control are provided on page 4.

Wiring Notes

- NC24T is designed for 24 VAC operating voltage
- Standard cables can be used for the controller, however, shielded cables are recommended when installed in an environment greatly exposed to EMI
- 22 or 24 AWG twisted shielded pair double-insulated cable is recommended as temperature sensor wiring and its length must not exceed 25 m
- Do not bundle and run power wiring and sensor wiring in a same conduit
- Run the sensor wires away from any electric motors or power wiring when external temperature sensor is connected. Failure to do so may result in poor controller performance due to electrical noise
- When several isolated double-wound step-down transformers are used in a control loop, observe the polarities of the AC power supply of all devices including the NC24T controller.

Wiring Diagrams

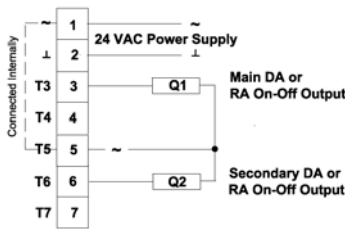

Wiring diagram for applications 1,2,3,4 and 5

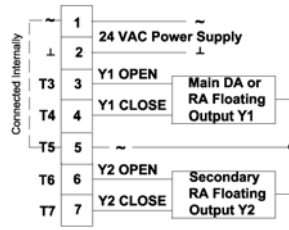

Wiring diagram for applications 6,7 and 8

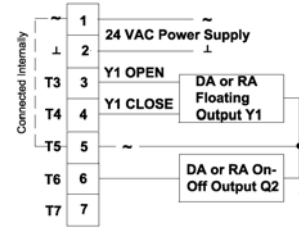

Wiring diagram for applications 9,11 and 12

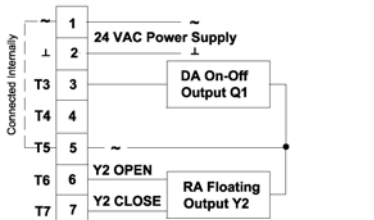

Wiring diagram for application 10

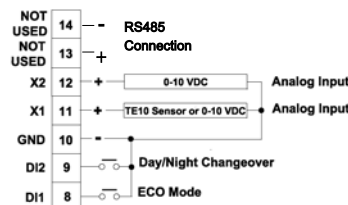

Wiring diagram for all applications Analog and Digital Inputs

Display Control Unit and LCD Layout

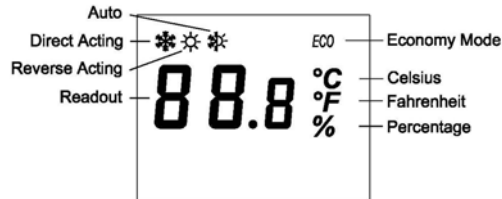
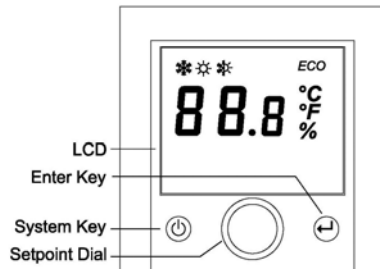

Operation Notes

- LCD shows measured value of analog input X1 constantly except when set-point adjustment is being made
- The backlight will turn on for 5 seconds when the adjustment dial is being rotated
- Increase or decrease set-point value by rotating the adjustment dial clockwise or counter-clockwise. During the dial rotation, the LCD shows the set-point value
- The controller allows authorized service agent to change the operating parameters and functions by pressing the system and enter keys as shown on following setup menu

Configuration and Parameter Setup Procedure

1. Configuration and parameter setup menu is accessible when the controller is energized excepts in Eco-mode
2. Press and hold the \leftarrow key for 5 seconds to enter into the configuration and parameter setup menu
3. After entering into the setup mode, press the Φ key consecutively to access desired configurations or operating parameters as shown below. The various configurations and operating parameters to be set are indicated with the 3-digit indicator. Details of each configuration and parameter are provided on setup menu shown on page 3.

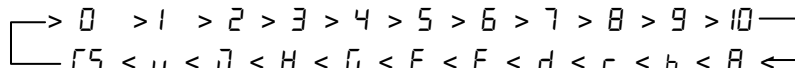

4. Rotate the dial to change the value when the desired parameter symbol is flashing.
5. Press and hold the \leftarrow key followed by pressing the Φ key then releasing the \leftarrow key and continuing to hold the Φ key for 2 seconds. The controller will resume to working mode with new settings of configuration and parameter after a beep sound.
6. The controller will exit setup mode automatically without saving new settings if there is no key operation for 30 seconds during setup procedure.

Symbol	Function	Description
0	MCU firmware revision level	LCD shows 0-<i>r</i> after entering the setup menu
1	Specific control applications	101 = application 01 - RA on-off output 102 = application 02 - DA on-off output 103 = application 03 - Dual RA on-off outputs 104 = application 04 - Dual DA on-off outputs 105 = application 05 - RA on-off and DA on-off outputs 106 = application 06 - RA Modulating output 107 = application 07 - DA Modulating output (Factory setting) 108 = application 08 - RA Modulating + DA Modulating outputs 109 = application 09 - RA on-off and DA Modulating outputs 110 = application 10 - RA Modulating + DA on-off outputs 111 = application 11 - RA on-off + RA Modulating outputs 112 = application 12 - DA on-off and DA Modulating outputs
2	Configuration of input X1	201 = active 0-10 VDC (factory setting) when socket inserted to pins 3&4 of JP3 202 = TE10 Series temp. sensor when socket inserted to pin 1&2 of JP3
3	Engineer unit	3-C = °C 3-F = °F 3-P = % (factory setting) 3-0 = no specified unit
4	Low-end value of sensing element readout (X1)	From -50 (when 202 and 3-C are set) or -99 (when 201 and 3-C or 201 and 3-F or 201 and 3-0 are set), or -58 (when 202 and 3-F are set) or 0 (when 201 and 3-P are set) (factory setting) To High-end value of X1 minus 4 units
5	High-end value of sensing element readout (X1)	From Low-end value plus 4 units To +110 (when 202 and 3-C are set) or +999 (when 201 and 3-C or 201 and 3-F or 201 and 3-0 are set), or +230 (when 202 and 3-F are set) or +100 (when 201 and 3-P are set) (factory setting)
6	Configuration of input X2	600 = no action (factory setting) 601 = remote set-point (local set-point is overridden by X2) 602 = higher input priority (X1 is overridden by X2 only when X2 is greater) 603 = higher output priority (0...10V calculated output is overridden by X2 only when X2 is greater)
7	Proportional band	From 1 to 20 when 3-C or 3-F or 3-P is selected (factory setting = 5 = 705) From 1 to 99 when 3-0 is selected
8	Integration time	From 0 to 30 mins (factory setting = 15 mins = 815) Integral time algorithm is turned off when setting is 0
9	Actuator stroke time for 3-point modulating outputs	From 10 to 240 seconds 901 = 10 seconds... 912 = 120 seconds (factory setting)... 924 = 240 seconds
10	Controller address setting	To set the slave device address from 1 to 32
A	Low-end value of X1 set-point range	From low-end value of sensing element readout X1 To high-end value of set-point range minus 4 units
b	High-end value of X1 set-point range	From low-end value of set-point range plus 4 units To high-end value of sensing element readout X1
c	Minimum limit of Y1 and Y2 outputs (Min %)	From 0 to value of maximum limit minus 10% 001 = 10% (factory setting)
d	Maximum limit of Y1 and Y2 outputs (Max %)	From value of minimum limit plus 10% to 100% d10 = 100% (factory setting)
E	ECO mode set-point of RA output(s)	From low-end value of set-point range To ECO mode DA set-point minus 4 units
F	ECO mode set-point of DA output(s)	From ECO mode RA set-point plus 4 units To high-end value of set-point range
G	Set-point differential (SD)	1 to 20 when 3-C , 3-F or 3-P is selected (factory setting = 1 = 001), or 1 to 99 when 3-0 is selected
H	Display offset for readout value of X1 input	-50 to +99 (factory setting = 0)
J	Control Bandwidth between set-point 1 and set-point 2 (functional only for application 3,4,5,8,9,10,11 and 12)	-99 to +99 (factory setting = 0)
u	Constant display of X1 input or local set-point value	u-1 = constant display of X1 input readout (factory setting) u-2 = constant display of set-point value
FS	Restoration of default factory settings	FS1 = Retain current settings (factory setting) FS2 = Restore default factory settings

Graphic Representation of Specific Control Applications

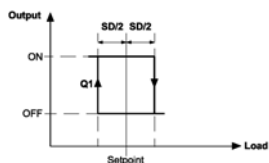

Application No. 1:
Single RA On-Off Output

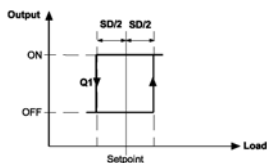

Application No. 2:
Single DA On-Off Output

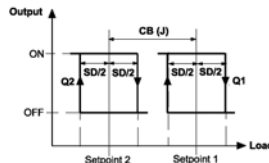

Application No. 3:
Dual RA On-Off Outputs

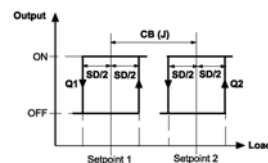

Application No. 4:
Dual DA On-Off Outputs



Application No. 5:
RA On-Off & DA On-Off Output

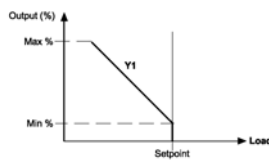

Application No. 6:
Single RA Modulating Output

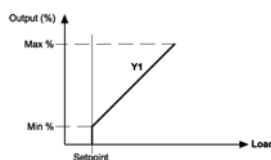

Application No. 7:
Single DA Modulating Output

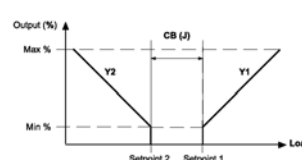

Application No. 8:
RA Modulating &
DA Modulating Output

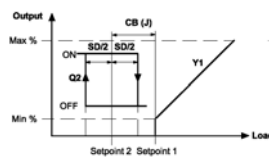

Application No. 9:
RA On-Off Output &
DA modulating Output

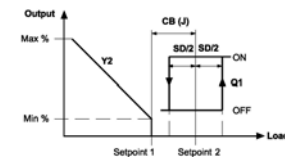

Application No. 10:
RA Modulating Output &
DA On-off Output

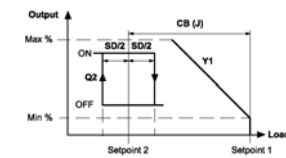

Application No. 11:
RA On-Off Output &
RA Modulating Output

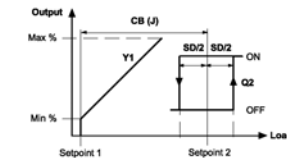

Application No. 12:
DA Modulating Output &
DA On-Off Output

Example of Setting Up Configurations and Parameters

Requirements:

- a. MAC address to be 16
- b. Application for 2-pipe cooling only with 3-point floating valve actuator (Application No. 7)
- c. Actuator stroke time is 120 seconds
- d. 0...50°C temperature transmitter (0-10 VDC active input)
- e. Set-point range = 0...50 °C
- f. 0-100% RH humidity controller (Higher output priority)
- g. P-band and I-time to be set as 5K and 15 minutes respectively (P = 5 and I = 15)
- h. ECO mode to be activated when sensing temperature is at or higher than 26°C (ECO mode DA set-point)
- i. Minimum and Maximum output limits to be 30% and 80% respectively
- j. Set-point Differential (SD) to be 1
- k. The controller displays set-point value constantly

Configuration and parameter setup steps:

1. Press and hold the \leftarrow key for 5 seconds to enter into configuration and parameter setup mode. LCD displays $\bar{0}$ -
2. Press the Φ key until $\bar{1}$ is flashing. Rotate the adjustment dial to change the value to $\bar{107}$
3. Press the Φ key until $\bar{2}$ is flashing. Rotate the adjustment dial to change the value to $\bar{20}$
4. Press the Φ key until $\bar{3}$ is flashing. Rotate the adjustment dial to change the value to $\bar{3-C}$
5. Press the Φ key until $\bar{4}$ is flashing. Rotate the adjustment dial to change the value to $\bar{0}$
6. Press the Φ key until $\bar{5}$ is flashing. Rotate the adjustment dial to change the value to $\bar{50}$
7. Press the Φ key until $\bar{6}$ is flashing. Rotate the adjustment dial to change the value to $\bar{603}$
8. Press the Φ key until $\bar{7}$ is flashing. Rotate the adjustment dial to change the value to $\bar{705}$
9. Press the Φ key until $\bar{8}$ is flashing. Rotate the adjustment dial to change the value to $\bar{8}$
10. Press the Φ key until $\bar{9}$ is flashing. Rotate the adjustment dial to change the value to $\bar{9}$
11. Press the Φ key until $\bar{10}$ is flashing. Rotate the adjustment dial to change the value to $\bar{16}$
12. Press the Φ key until $\bar{11}$ is flashing. Rotate the adjustment dial to change the value to $\bar{0}$
13. Press the Φ key until $\bar{12}$ is flashing. Rotate the adjustment dial to change the value to $\bar{50}$
14. Press the Φ key until $\bar{13}$ is flashing. Rotate the adjustment dial to change the value to $\bar{c03}$
15. Press the Φ key until $\bar{14}$ is flashing. Rotate the adjustment dial to change the value to $\bar{d08}$
16. Press the Φ key then LCD displays flashing \bar{E}
17. Press the Φ key until $\bar{15}$ is flashing. Rotate the adjustment dial to change the value to $\bar{26}$
18. Press the Φ key until $\bar{16}$ is flashing. Rotate the adjustment dial to change the value to $\bar{c0}$
19. Press the Φ key then LCD displays flashing $\bar{1}$.
20. Press the Φ key until $\bar{17}$ is flashing. Rotate the adjustment dial to change the value to $\bar{u-2}$
21. Press and hold the \leftarrow key followed by pressing the Φ key then releasing the \leftarrow key and continuing to hold the Φ key for 2 seconds. You will hear a beep sound and the controller will resume to working mode with new settings of configuration and parameter.