

Product Overview

The UC24A Universal Controller is designed for Heating, Ventilating, Air-conditioning and Refrigeration in comfort control of industrial, commercial and residential environments. It can be mounted on a control panel or on wall in plant rooms.

Measurement and control of temperature, relative humidity, absolute humidity, enthalpy, pressure differential, volumetric airflow and indoor air quality. The input scale can be set from -99 to 999 units. The start and end points of output voltage can be any value between 0 to 10 VDC.

UC24A standalone controller provides two direct or reverse 0...10 VDC outputs and one direct or reverse 2-position on-off output. 9 selectable control functions are provided for various applications.

Features

- 24 VDC supply voltage
- Modern Appearance
- Stylish rotary dial and touch key
- Large LCD with backlight
- One universal input + one 0...VDC input
- Two 0...10 VDC outputs + one 2-position 24 VAC on-off output
- PI Algorithm
- Eco-mode DI for energy saving purpose
- Day / night DI for action changeover
- Retention of last settings upon power failure
- Configuration and Parameter setup menu
- Customizing availability

Ordering

To order the UC24A Universal Controller, contact the nearest Cyrus' representative. Specify the desired product code number from product overviews.



Selectable Functions

- 9 control applications
- Primary input can be configured to accept TE10 series temp. sensor or 0...10 VDC output device
- Selections of °C, °F, % or no specified unit
- Selectable display range
- Secondary 0...10 VDC input for remote set-point, higher input priority or higher output priority
- Adjustable P-band and I-time
- Selectable set-point range
- Selectable 0...10 VDC output limits
- Selectable Eco-mode set-points
- Adjustable set-point differential
- Adjustable control bandwidth
- Measured value reading offset
- Display selections between measured value of Input 1 or set-point value

Display Control Unit and LCD Layout

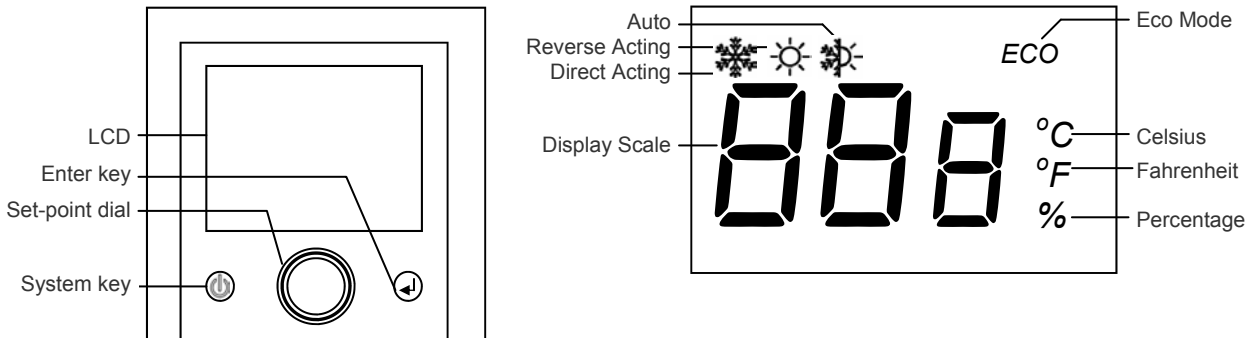

Operation Notes

Display	LCD shows measured value constantly except when set-point adjustment is being made
Backlight	The backlight will light up for 5 seconds when any button is pressed
Set-point	Increase or decrease set-point by turning the rotary dial
System and Enter Keys	The controller allows authorized service agent to change the certain number of operating parameters and configurations via pressing system and enter keys, please refer to installation and configuration menu for details.

Controller Type and functions

The UC24A is a standalone universal controller which performs both primary and auxiliary control functions. The respective mode is defined by settings of configurations and parameters via entering into setup mode.

The controller can be configured as follows:

<input type="checkbox"/>	One sequence	Q1 Y1	reverse or direct acting
<input type="checkbox"/>	Two sequences	Y1 and Y2 Q1 and Y1 Y2 and Q1 Q1 and Y2 Y1 and Q1	reverse and direct acting reverse and reverse acting direct and direct acting

Inputs and Outputs

Input / Output	Terminal No.	Description
Universal input X1	11	Universal input X1 can be used as the primary input with a TE10 Series NTC temperature sensor or an active 0...10 VDC active signal. Refer to jumper table and setup menu for details of settings
Analogue input X2	12	The analog input X2 is used as the secondary input with a 0...10 VDC active signal that allows remote set-point override, higher input priority or higher output priority. Refer to setup menu for details of configurations.
Digital input DI1	8	The digital input DI1 is used to activate the ECO-mode (Energy-saving mode)
Digital input DI2	9	The digital input DI2 is used to activate day/night changeover.
Analog output Y1	3	0...10 VDC modulating output for either reverse or direct acting
Analog output Y2	5	0...10 VDC modulating output for reverse acting
Digital output Q1	6&7	24 VAC 2-position output for either reverse or direct acting

Application examples

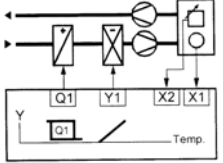
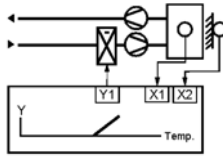
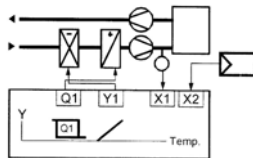
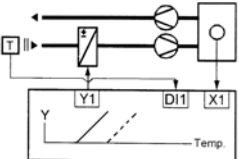
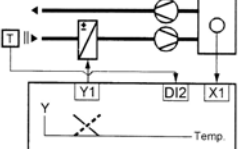
Remote Set-point	A remote signal of 0...10VDC is given to X2 that is configured as local set-point override	
Higher Input Priority	X2 will be used as an calculated variable for modulating output and LCD will display its equivalent value when is greater than X1	
Higher Output Priority	The value of input X2 will be directly used as output Y1 when X2 is greater than the calculated output of cooling	
Eco-Mode	The set-point will be offset to Eco-mode set-point when wiring terminal 8 and 10 of DI 1 is in closure	
Day / night changeover	A digital switch is connected to wiring terminal 9 and 10 of DI2 to implement day / night changeover action. Invert action is activated when wiring terminal 9 and 10 is in closure	

Remarks:

Illustrations of application specific control are provided on page 4. Please refer to the setup menu for configuration details of X1, X2 and Eco-mode function.

Application specific controls

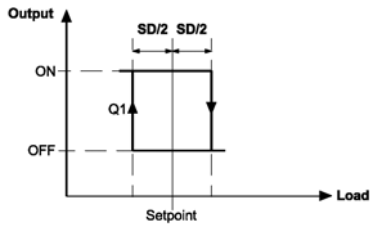

Application No. 1:
Single RA On-Off Output

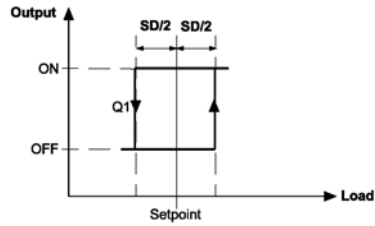

Application No. 2:
Single DA On-Off Output

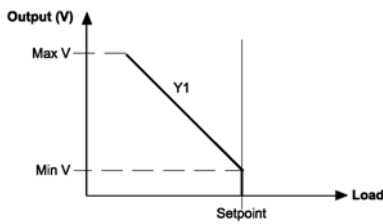

Application No. 3:
Single RA 0(2)-10VDC Output

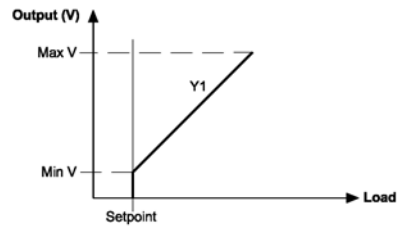

Application No. 4:
Single DA 0(2)-10VDC Output

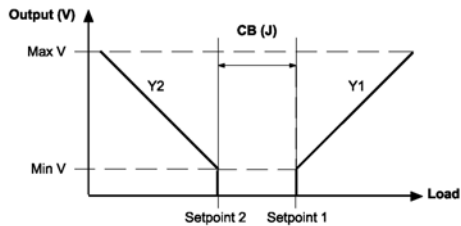

Application No. 5:
RA 0(2)-10VDC + DA 0(2)-10 VDC

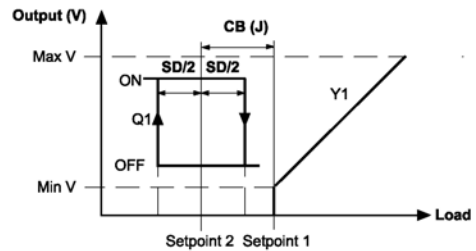

Application No. 6:
RA On-Off + DA 0(2)-10 VDC Outputs

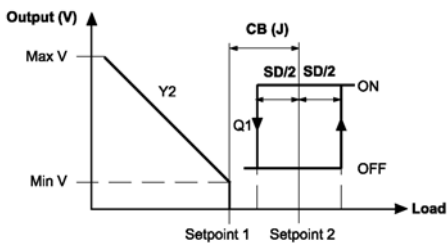

Application No. 7:
DA On-Off + RA 0(2)-10 VDC Outputs

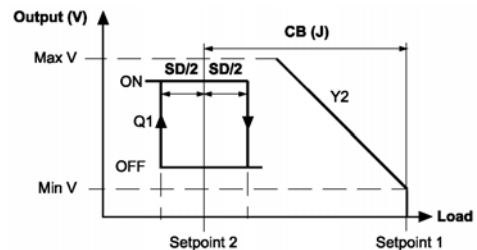

Application No. 8:
RA On-Off + RA 0(2)-10 VDC Outputs

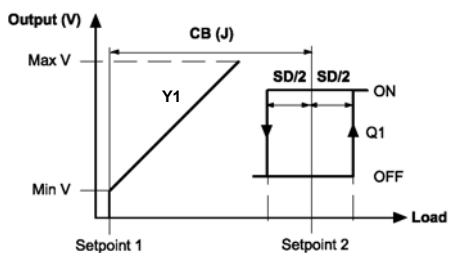

Application No. 9:
DA On-Off + DA 0(2)-10 VDC Outputs

Technical Specifications

Product Model	UC24A
Power Requirements	24 V \pm 15% 50/60 Hz
LCD	3 digits
Display range	-99...999
Set Point Range	-99...999
Universal Input X1	TE10 NTC temperature sensor (-50...110 °C), or 0...10 VDC active input corresponding to adjustable (°C, °F, % or no unit)
Secondary Analogue Input X2	0...10 VDC active input
DI 1 and DI 2	Input signal from external voltage-free contact
Analogue Output Y1 and Y2	0...10 VDC Minimum 50,000 Ω output impedance
Digital Output Q1	20 VA @ 24 VAC
Body Material	Self-extinguishing, molded ABS
Ambient/Storage Temperature Limits	0 to 50 °C / -30 to 50 °C, 10% to 90% RH non-condensing
Agency Approval	CE Mark compliant to EMC and low voltage directives
Shipping Weight	120 g
Dimensions	See Dimensions drawing in mm

Dimensions (mm) and Mounting

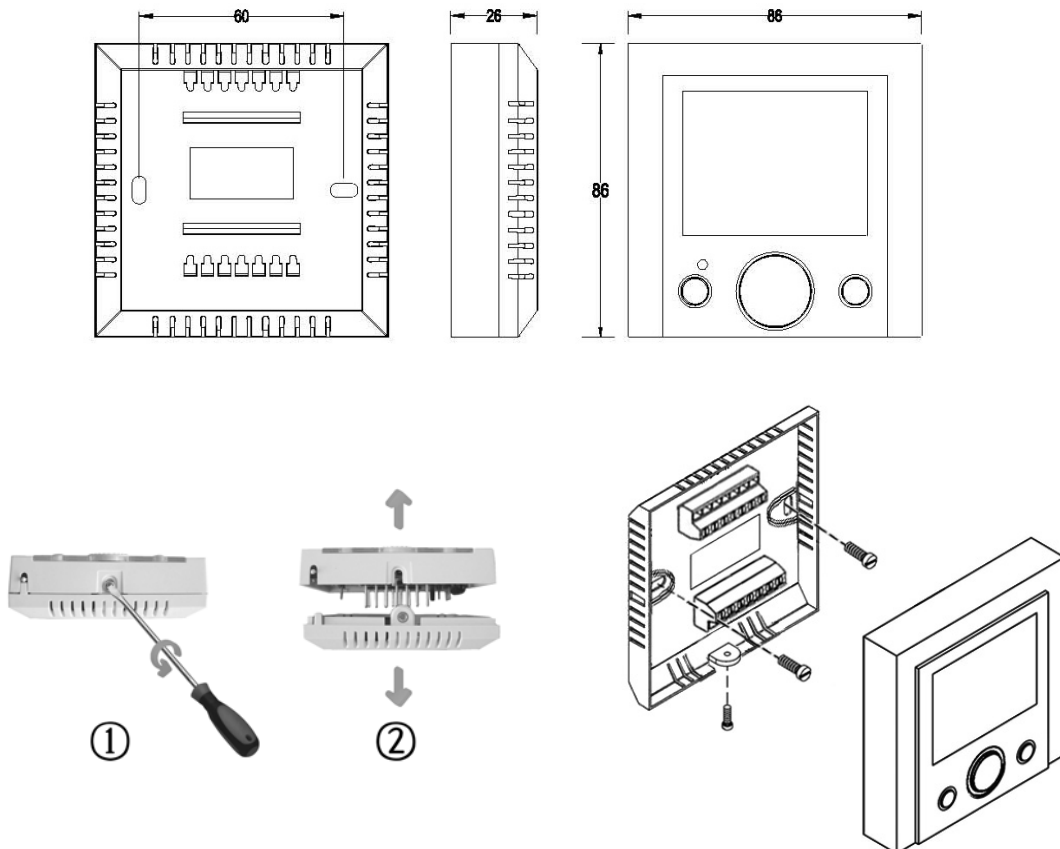

Wiring Terminals and Jumper Settings

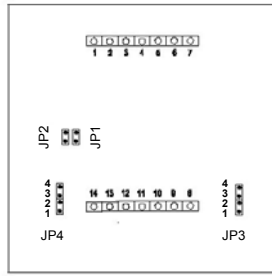
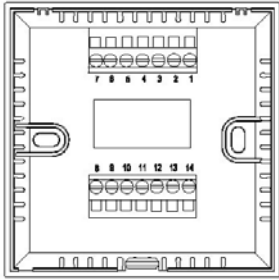

Jumper Settings	
Jumper	Socket Position
JP1	Always at open position
JP2	OPEN for 2...10 V, CLOSED for 0...10V (Factory Setting)
JP3	Insert at position 3 & 4 for 0...10 V active input (Factory setting), Insert at position 1 & 2 for TE10 sensor input
JP4	Always at position 3 & 4

Electrical Installation

- UC24A is designed for 24 VAC operating voltage
- Standard cables can be used for the controller, however, shielded cables are recommended when installed in an environment greatly exposed to EMI
- Remove jumper JP2 to open position if 2-10 VDC proportional output is required
- 22 or 24 AWG twisted shielded pair double-insulated cable is recommended as temperature sensor wiring and its length must not exceed 25 m
- Do not bundle and run power wiring and sensor wiring in a same conduit
- Run the sensor wires away from any electric motors or power wiring when external temperature sensor is connected. Failure to do so may result in poor controller performance due to electrical noise
- When several isolated double-wound step-down transformers are used in a control loop, observe the polarities of the AC power supply of all devices including the UC24A controller.

Wiring Diagram

